

Model DDO61GA

Introduction

This gas appliance has been designed and manufactured to all the necessary British Standards. It also carries the C.E. mark. The appliance complies with European Council Directive 90/396/EEC.

It is important that you understand how to use and care for the appliance properly before you use it for the first time.

We have written this booklet with your safety in mind. Read the booklet thoroughly before you use the appliance. Keep the booklet in a safe place so that anyone who uses the appliance can read it. Pass the booklet on with the appliance if you sell it to someone else.

For your safety

This appliance is not intended to be operated by means of an external timer or separate remote control system.

The appliance is designed to cook food and you must not use it for any other purpose.

Keep children, babies and toddlers away from the appliance at all times.

The installation instructions that came with the appliance tell you how and where it can be fitted. If the appliance is already installed you must make sure that all instructions have been followed. If you are in any doubt ask a competent person. More details on installation on page 32.

We have included several drawings to show the right and wrong way of doing things.

The right way will have a smiling face by it.



A sad face shows something is wrong.



RATING PLATE

This is situated on the lower front frame of the appliance and can be seen upon opening the door. Alternatively the rating plate may also be found on the back or top of some models (Where applicable). **Do not remove the rating plate from the appliance as this may invalidate the guarantee.**

Contents	Page
Lighting the appliance	4
The grill	7
The hotplate	10
The ovens	13
Oven cooking chart - main oven	16
- second oven	19
The electronic minute minder	22
Slow cooking	24
Care and cleaning	26
Installing the appliance	32
General information	34
What is wrong and why?	36
Servicing	38
Installation Instructions	40
Technical Data	41
Safety requirements/ventilation	42
Location of appliance	43
Installation	44
Testing	46
Guarantee Conditions	49

Lighting the appliance

The system works by means of an electric spark system. Details about the plug are given on page 34.

Hotplate

To light

1. Lift up the lid. You cannot use the hotplate when the lid is down.
2. Push in the control knob and turn it to the large flame symbol (highest setting), and press the ignition button immediately. When the burner has lit release the button.

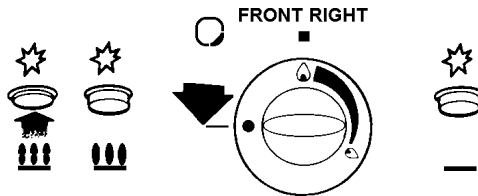

Warning: If the ignition button is not pressed a build up of gas may cause the flame to spread.

For your safety

If you close the lid of the appliance while any of the hotplate burners are lit the gas will go out. This is because it would be dangerous if the burners stayed on when the lid was closed.

Always use the control knob to turn off a burner. Do not use the lid as a cut-off device. This will only cut off the gas when the lid is closed. The gas will flow again when the lid is opened.

Please note: If you have any trouble lighting a hotplate burner turn all the hotplate control knobs off and make sure the hotplate burner parts have been replaced correctly.

See page 27 for more information.

Grill/second oven

The grill and the second oven are operated by the same control so you cannot use them both at the same time.

Grill

To light:

- 1 Open the door.
- 2 Push in the control knob and turn it to the right to the highest setting. This is shown by a large flame symbol. Press the ignition button. When the burner has lit release the button.

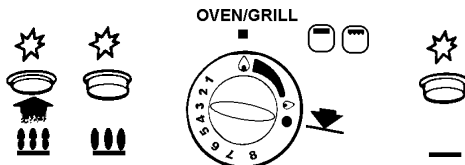

- 3 Leave the grill door open when you are using the grill.

Warning : If the ignition button is not pressed immediately a build up of gas may cause the flame to spread.

For your safety

Never cover the grill pan or grid with foil as this can lead to grill fires

Second oven

To light:

- 1 Open the oven door.
- 2 Push in the control knob and turn it to the left to gas mark 1. Press the ignition button. When the burner has lit release the button. There will only be small flames at first.

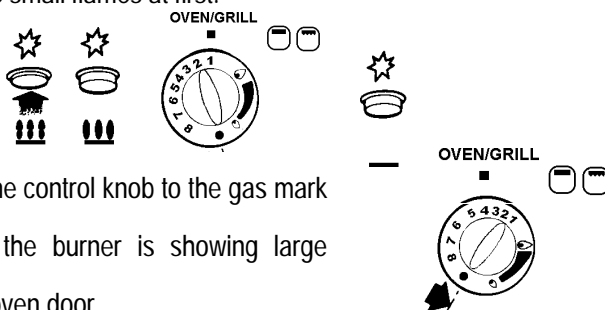

- 3 Now turn the control knob to the gas mark you want.
- 4 Wait until the burner is showing large flames.
- 5 Close the oven door.

Important: Remember to remove the grill pan handle before you use the second oven.

Main oven

To light:

- 1 Set the time of day on the clock. See page 22
- 2 Open the oven door.
- 3 Push in the control knob and turn it to gas mark 9. After a few seconds the oven will light automatically and the oven light will illuminate.

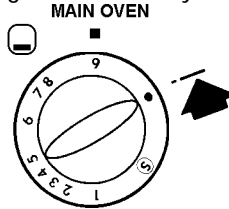

- 4 Now turn the control knob back to the gas mark you want.
- 5 Wait until the burner is showing large flames
- 6 Close the oven door.

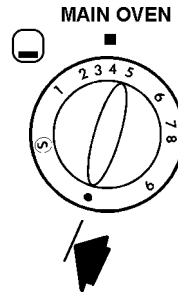

If there is an electrical power failure (such as a power cut) you cannot use the main oven. You can use the second oven.

To turn off any burner

- 1 Push in the control knob and turn it to the off position. This is shown by a large dot.

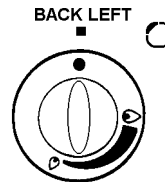
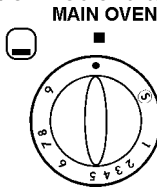

For your safety

When you are lighting any burner check that it has lit before you leave the appliance.

When you are turning off a burner, **do not** leave the appliance until the flame has gone out.

Oven light

The main oven light will come on when the oven burner is alight. If you need to replace the oven light bulb, follow the instructions given on page 35.

The grill

The grill is a high-speed grill. The instructions below tell you how to vary the heat setting and how to change the height of the grid to suit the food you are cooking. You should remember to turn the food regularly.

You should not use the grill to keep food warm as it will continue to cook the food.

Prior to using the grill

We suggest that you operate the grill for approximately 5 - 10 mins to burn off any residue from the surface. During this period a slight odour may be emitted, it is therefore advisable to open a window for ventilation.

When you first operate the grill you may hear some sounds as the burner heats up, this is quite normal and is not a fault on the appliance.

For your safety

The grill pan and handle must be in place before igniting the grill. You must keep the grill door open when the grill burner is lit. Accessible parts may be **hot** when the grill is used. Young children should be kept away. Never cover the grill pan or grid with foil as this can lead to grill fires.

Heat control

The grill control has two heat settings.

The control knob turns to the right from 'OFF' to 'LOW' and then to 'HIGH'. Use the high setting for fast cooking such as toast. Use the low setting to cook thicker food such as chicken after you have browned it on the high setting.

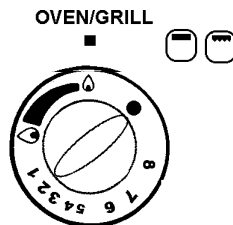

Cooking positions

There is only one position for the grill shelf (Position 2). Positions are counted from the top downwards.

Most food should be cooked on the grid in the grill pan. You can turn the grid over to suit different thicknesses of food.

You can place some dishes straight on to the grill shelf. This is useful when you are browning the top of food such as cauliflower cheese.

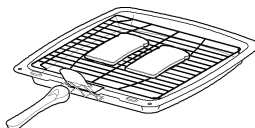
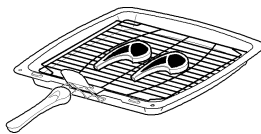

General

The shelf in the grill/second oven is different from the shelves in the main oven. It is important that you **do not** swap them over. Only use the shelf with the solid metal plate underneath it in the grill/second oven.

When you are not using the grill you should remove the handle and store the pan on the shelf in the grill. Turn the grill burner off before you store the pan. Remember that the pan will get **hot** when you are using the main oven.

You can use the grill compartment to warm plates when you are using the main oven.

Preheating

You don't usually need to preheat the grill. You may wish to preheat it for a couple of minutes when you are cooking steak or browning food.

Positioning food on the grid

Place food such as toast, tea-cakes and muffins towards the centre of the grid.

Place food which needs a gentle heat, such as tomatoes and mushrooms towards the edge of the grid.

Arrange meat, meat products and fish to suit their thickness and how you like them cooked.

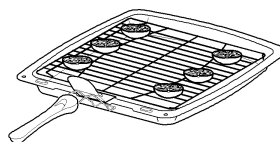
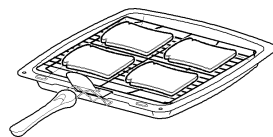

The grill pan and handle

The grill pan is supplied with a removable handle.

To attach the handle, place the wirework under the cut out in the pan so that the metal plate hooks over the top of the grill pan.

Slide the handle to the left and over the central bump on the grill pan.

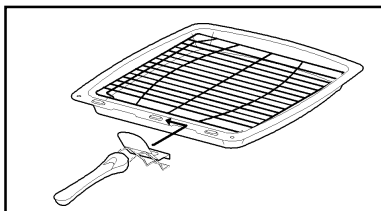

Ensure the handle is correctly located. It is not necessary to remove the grill pan handle during grilling.

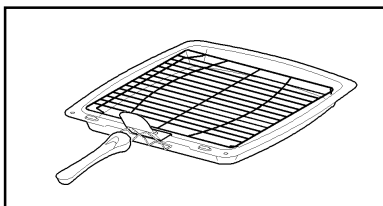

Place the grill pan on the shelf so that the pan is positioned centrally beneath the grill.

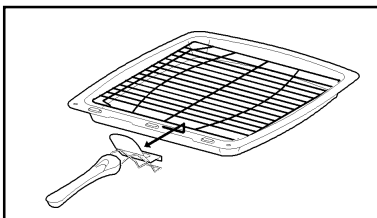

To remove the handle, slide the handle to the right and lift the handle away from the cut out on the grill pan.

Note

If you require an additional handle for your grill pan, this can be ordered from your local Service Force Centre by quoting part number 311479800\6.

The hotplate

You can only use the hotplate when the lid is open. If you have any trouble lighting a hotplate burner turn all hotplate control knobs off and make sure the hotplate burner parts have been replaced correctly. See page 27 for more information.

Heat control

The hotplate control knobs turn anticlockwise from 'OFF' to 'HIGH' and then to 'LOW'. You can adjust the heat by turning the control between the highest and lowest settings. These are shown as a large and a small flame symbol.

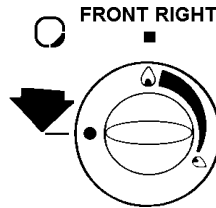

Burner sizes

The hotplate has three burner sizes to suit different types of cooking:

Largest burner (Rapid) - use a large pan for food such as chips.

Medium burners (Normal) - use for everyday cooking.

Small burner (Simmer) - use for simmering food such as soups and stews.

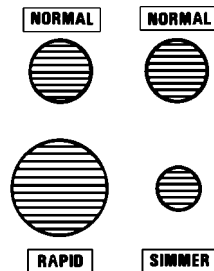



The largest pan which you should use on any burner is 230mm (9").
The base of the smallest pan should not measure less than 100mm (4").



For your safety



1  Take care to avoid burns and scalds when you are reaching across the hotplate.

2  Use pans with flat bases. They are more stable than pans which are warped.



3  **Do not** use pans with very heavy handles which cause the pan to tip.



4  Put pans on the centre of the burners.



5  Position pan handles so they cannot be accidentally knocked.



6  Take extra care when you are deep fat frying. **Do not** cover the pan with a lid.



 **Do not** leave a pan unattended. If the pan catches fire, leave it where it is and turn off all controls.



Place a damp cloth or a fitting lid over the pan to smother the flames.

Never put water on the fire.



Leave the pan to cool for 30 minutes.

7  If you are using a Wok we recommend it has a flat base as it will stand stable on the pan supports. If you use a round based Wok with a collar support, the collar must be of the open wire work type. A closed collar will affect the performance of the burner. Before you use the Wok make sure that the collar is stable on the pan supports. Always follow the instructions that come with the Wok.



8 **Do not** use the lid as a work surface or chopping board. This could damage the glass and reduce its strength.



Helpful hints



1



Keep flames under the base of pans. If the flames lick round the sides of the pans you are wasting gas.



2



Only heat the amount of liquid you need. **Do not** overfill pans.

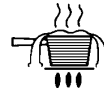

3



Cover pans with a lid whenever possible. The food will heat up more quickly and there will be less steam in the kitchen.



4



Try cooking more than one vegetable in the same pan, for example potatoes and carrots.

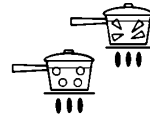

5



Cut vegetables into smaller pieces. This way they will cook more quickly.



6

A pressure cooker will save time and energy.

The ovens

Before you use the ovens you should wipe them out with a damp cloth to remove any dust.

Heat zones

Main oven - There are zones of heat within the oven. The temperature in the middle is the gas mark you have chosen. The top of the oven is slightly hotter and the lower shelf slightly cooler. The base of the oven is quite a lot cooler. You can make use of these heat zones when you are cooking foods that need different temperatures all at the same time.

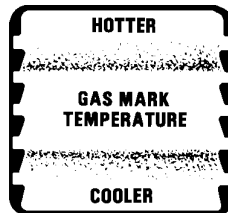

If you are cooking more than one tray of similar items, for example cakes or biscuits, swap the trays around during cooking. Or you can remove the top tray when the food is cooked and move the lower tray to the higher shelf to finish cooking.

Second oven - You should turn food round during the cooking time.

Preheating

You do not need to preheat the main or second oven for casseroles and so on.

Preheat the ovens for baking or when you are cooking sensitive food such as Yorkshire puddings, soufflés and yeast mixtures.

When you are cooking or reheating frozen or chilled food read the instructions on the packaging. When you are using the second oven to reheat food you should preheat the oven to gas mark 8. When you need to preheat the oven, we recommend you do so for 20 minutes.

Oven shelves

You can slot the oven shelves into any of five positions in the main oven and any of the two positions in the second oven. Positions are counted from the top downwards.

The shelf in the grill/second oven is different from the shelves in the main oven. Only use the shelf with the solid metal plate underneath it in the grill/second oven. The plate may glow red when you are using the oven. This will not affect the cooking performance.

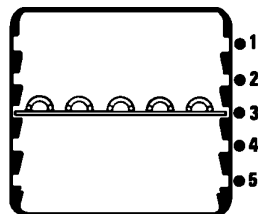

Most second oven cooking should be carried out using the shelf provided in shelf position 2. However when cooking a small joint or a deep cake you can use the shelf on the base of the second oven to allow enough air to circulate around the food.

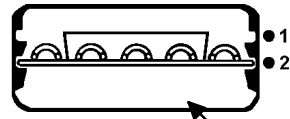

Shelf on base

For safety the shelves will only pull out so far. If you want to remove a shelf completely, pull it forward as far as it will go, raise the front edge and lift it out. To put the shelf into a different position, keep the front edge raised, slot the shelf on to the runner, lower the front edge and slide the shelf in.

Baking trays and dishes





For your safety







Never place cooking dishes, trays and so on over the oven burners. This will damage the appliance as well as the cookware and possibly the floor covering underneath the appliance.



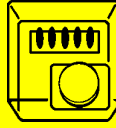

Leave a gap of 13mm ($\frac{1}{2}$ ") between all dishes and the sides of the oven so the heat can circulate properly.





Do not push dishes too far back as food will burn if it overhangs the burner flames.

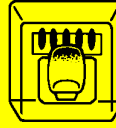

For the best results from the main oven we recommend that you use a baking tray which is 310mm (12") square. If you use a tray or tin which is larger than this, you may need to turn it around during cooking.

The size of tray which should be used in the second oven should not be bigger than 310mm x 230mm (12" x 9"). Place the longest side parallel with the door.

Place single dishes on the centre of the shelf. You may need to turn large items around during cooking. Turn all food round in the second oven.

Roasting

For best results we recommend open roasting using minimal fat or oil to prevent splashing.

It is not necessary to cover meat or poultry or wrap food in foil when roasting as this restricts the circulation of heat and will lead to extended cooktimes.

If you are using a roasting bag or cover chicken breast with foil, be prepared to allow an extra 10 - 15 minutes for each 1/2kg (1lb).

When cooking large items such as turkeys, the use of foil may be required to prevent the breast becoming dry before the rest of the bird is fully cooked.

Condensation

Condensation may form on the appliance. This is quite normal and nothing to worry about. The condensation forms when heat and moisture are present, for example during cooking. Whenever possible try to make sure that food which contains a lot of moisture, for example casseroles, are covered. If you do notice any condensation, wipe it up straight away.

Oven cooking chart - Main oven

These instructions are for cooking in the oven after it has been pre-heated for 20 minutes.

If you are cooking more than one tray of similar items, for example cakes or biscuits, swap the trays around during cooking or you can take the top tray out of the oven when the food is cooked and move the lower tray to the higher shelf to finish cooking.

Always leave at least one shelf position between shelves to allow heat to circulate.

The recommended shelf positions give the best results.

Put the dishes in the centre of the shelf.

You can change the gas marks and cooking times to suit your own tastes.

It is important to check that food is piping **hot** before serving.

If you are using both ovens at the same time you may need to adjust the cooking times.

Food	Gas mark	Shelf position	Approximate cooking time
Roasting meat: Beef	5	4	Rare: 20 mins. per ½ kg (1lb) and 30 mins. Medium: 25 mins. per ½ kg (1lb) and 25 mins. Well Done: 30 mins. per ½ kg (1lb) and 30 mins.
Lamb	5	4	Medium: 25 mins. per ½ kg (1lb) and 25 mins. Well Done: 30 mins. per ½ kg (1lb) and 30 mins.
Pork and Veal	5	4	Medium: 30 mins. per ½ kg (1lb) and 30 mins. Well Done: 35 mins. per ½ kg (1lb) and 35 mins.

Thaw frozen joints thoroughly before cooking them.

Food		Gas mark	Shelf position	Approximate cooking time
Poultry:	Chicken	5	4	20 mins. per ½kg (1lb) and 20 mins.
	Turkey below 4.5kg (10lbs)	4	4	25 mins. per ½kg (1lb) and 25 mins.
	over 4.5kg (10lbs)	4	4 or 5	15 mins. per ½kg (1lb) and 15 mins.
	Duck and duckling	5	4	25 mins. per ½kg (1lb)
	Stuffed poultry	Cook as above but calculate weight including stuffing.		
Thoroughly thaw frozen joints before cooking them.				
The times given above are for open roasting in a preheated oven. If you cover the food with foil or a lid allow an extra 10 - 15 minutes for each ½kg (1lb).				
Yorkshire pudding	- large	7	2	25 - 30 mins.
	- individual	7	2	15 - 25 mins.
Cakes:	Christmas Cake (8")	2	4	4 - 5 hours.
	Rich fruit, 180mm (7")	2	4	2¼ - 2¾ hours.
	205 mm (8")	2	4	2½ - 2¾ hours.
	Madeira, 180 mm (7")	4	4	1 hour.
	Small cakes	5	2 & 4	15 - 25 mins.
	Scones	7	2 & 4	10 - 20 mins.
	Victoria Sandwich			
180mm (7")	4	2 & 4	20 - 30 mins.	
205 mm (8")	4	2 & 4	20 - 35 mins.	

Food		Gas mark	Shelf position	Approximate cooking time
Pastries:	Plate tart (shortcrust)	6	2	25 - 35 mins.
	Fruit pie (shortcrust)	6	2	25 - 35 mins.
	Mince pies (flan pastry)	5	2 & 4	15 - 25 mins.
To help pastry brown on the underside cook on a metal plate, or if plates are flat and have no rim underneath, place on baking tray.				
Puddings:	Milk pudding	2	3	2 hrs. approx.
	Baked sponge pudding	4	4	45 - 60 mins.
	Baked custard	3	4	50 - 60 mins.
Yeast mixtures:	Bread 0.45 kg (1lb loaves)	8*	3	30 - 40 mins.
	0.90 kg (2 lb loaves)	8*	3	30 - 40 mins.
	Rolls and buns	8*	2	10 - 20 mins.

* Note: When baking bread, cook for 10 minutes at Gas mark 8 then reduce to mark 6 for the remaining cook time.

Note: You must soak dried beans then boil them in an open pan for 15 minutes before you add them to any dish.

Oven cooking chart - Second oven

These instructions are for cooking in the oven after it has been pre-heated for 20 minutes.

The recommended shelf positions give the best results.

Put the dishes centrally on the shelf and turn food round during the cooking time.

You can change the gas marks and cooking times to suit your own tastes.

It is important to check that food is piping **hot** before serving.

If you are using both ovens at the same time you may need to adjust the cooking times.

Food		Gas mark	Shelf position	Approximate cooking time	
Roasting meat:	Beef	5	Shelf on base	Rare:	20 mins. per ½ kg (1lb) and 30 mins.
				Medium:	25 mins. per ½ kg (1lb) and 25 mins.
				Well Done:	30 mins. per ½ kg (1lb) and 30 mins.
	Lamb	5	Shelf on base	Medium:	25 mins. per ½ kg (1lb) and 25 mins.
				Well Done:	30 mins. per ½ kg (1lb) and 30 mins.
	Pork and Veal	5	Shelf on base	Medium:	30 mins. per ½ kg (1lb) and 30 mins.
				Well Done:	35 mins. per ½ kg (1lb) and 35 mins.

Thaw frozen joints thoroughly before cooking them.

Food	Gas mark	Shelf position	Approximate cooking time
Poultry:			
Chicken	5	Shelf on	20 mins. per ½kg (1lb) and 20 mins.
Duck and duckling	5	base	25 mins. per ½kg (1lb).
Stuffed poultry	Cook as above but calculate weight including stuffing.		

Thaw frozen joints thoroughly before cooking them.

The times given above are for open roasting in a preheated oven. If you cover the food with foil or a lid allow an extra 10 - 15 minutes for each ½kg (1lb).

Yorkshire pudding	- individual	7	2	20 - 30 mins.
Cakes:				
	Christmas Cake (7")	2	Shelf	3½ - 4½ hours.
	Rich fruit, 180mm (7")	2	on	2 - 2½ hours.
	Madeira, 180mm (7")	4	base	1 hour.
	Small cakes	5	2	15 - 25 mins.
	Scones	7	2	8 - 12 mins.
	Victoria Sandwich			
	180mm (7")	4	2	20 - 30 mins.

Pastries:	Plate tart (shortcrust)	6	2	25 - 35 mins.	To help pastry brown on the underside cook on a metal plate, or if plates are flat and have no rim underneath, place on baking tray.
	Fruit pie (shortcrust)	6	2	25 - 35 mins.	
	Mince pies (flan pastry)	5	2	15 - 25 mins.	

Food		Gas mark	Shelf position	Approximate cooking time
Puddings:	Milk pudding	2	2	2 hrs. approx.
	Baked sponge pudding	3	2	45 - 60 mins.
	Baked custard	3	2	50 - 60 mins.

Note: You must soak dried beans then boil them in an open pan for 15 minutes before you add them to any dish.

THE ELECTRONIC MINUTE MINDER

Button 1 = (-) Decrease control and minute minder setting button

Button 2 = (+) Increase control

(🔔) Bell Symbol

The electronic minute minder can also be used to show the time of day.

Please note that this is a 24 hour clock, for example 2pm is shown as 1400.

In the following pages we explain how to use the minute minder and set the time of day. Read through them until you're familiar with the procedure.

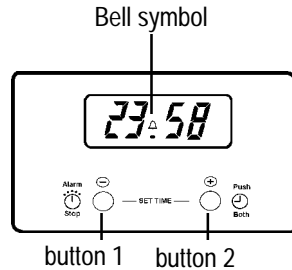

If the oven is switched off on the wall or there is a loss of power, the clock will stop and you will not be able to use the oven.

1) TO SET THE TIME OF DAY

When the electricity supply is first switched ON, the display will flash 0.00 See Fig1.

Press buttons (1) and (2) together.

Release the buttons, 0.00 will appear in the display as Fig 2. **Within 5 seconds** press button 2. 12.00 will show in the display as Fig 3.

Within 5 seconds press and hold either button (1) to decrease or button (2) to increase the time until the correct time of day on the 24 hour clock is reached, eg 14.30 See Fig 4

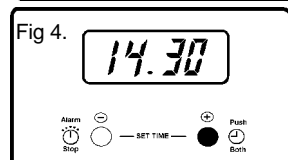
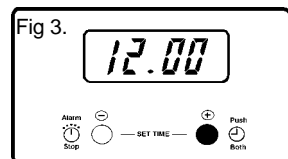
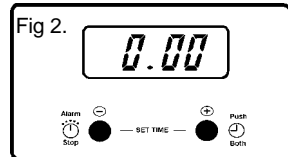
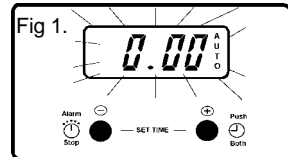

2) TO USE THE MINUTE MINDER

The minute minder gives an audible reminder at the end of any period of cooking up to 23 hours and 59 minutes.

To set press button (1) and the display will read 0.00, See Fig 5.

Release button (1) and press and hold button (2). The display will count up in one minute intervals until the interval to be timed is reached, eg 30 minutes, See Fig 6. If necessary press and hold button (1) to achieve the correct time interval.

The bell symbol will show in the display.

The minute minder will begin to count down once set. The time of day will show in the display. To show the remainder of the cook time press button (1).

At the end of the time period an audible signal will sound for up to 2 minutes. The bell symbol will flash and the time of day will show in the display. See fig 7.

To stop the sound press button (1). The bell symbol will go out and show the time of day eg 15.00. See Fig 8.

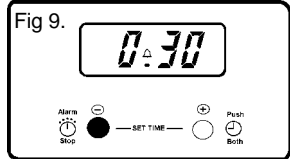
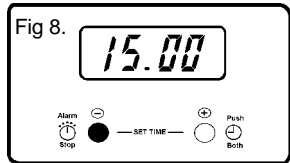
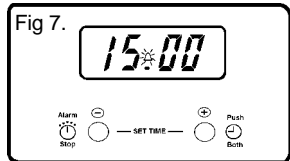
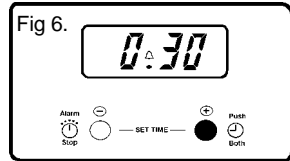
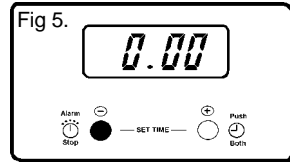

3) TO CANCEL THE MINUTE MINDER

If you change your mind and want to cancel the minute minder.

Press and release button (1). See Fig 9. Press and hold button (1) and the display will count down in one minute intervals to 0.00. See fig 10. Release button (1). After a few seconds the time of day will show in the display. See Fig 11

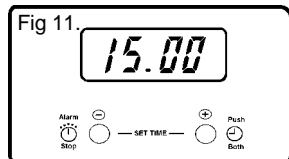
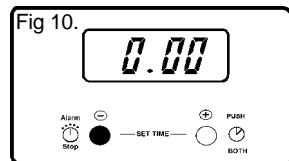

Slow cooking

Please note: There is no slow cook on the second oven.

The slow cook setting gives a very low heat in the oven. It is particularly useful when you are cooking soups, stews and casseroles because the long slow cooking will make cheaper, tougher cuts of meat more tender.

You need to cook food at gas mark 6 for 30 minutes before you turn the oven down to the slow cook setting. This makes sure that the temperature of the food gets **hot** enough to start the food cooking.

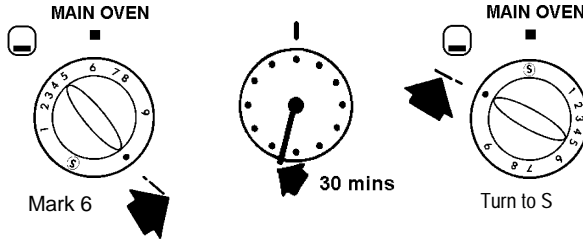

Some foods such as pastry and biscuits are not suitable for slow cooking because the temperature is too low.

Cover all food during cooking to prevent it from drying out. You can uncover food for the last half hour if it is normally served golden brown.

Food preparation - slow cooking

Joints of meat and poultry

- **Do not** cook meat joints over 2.7kg (6lb).
- **Do not** cook poultry over 2kg (4lb 8oz).
- Cook on the middle shelf of the oven or above.
- Cook stuffing separately.
- Cook for a minimum of 6 hours.
- Joints of pork must only be cooked if you can ensure, by using a meat thermometer, that an internal temperature of at least 88°C has been reached.
- For good air circulation always stand joints on a rack in a roasting tin or casserole.
- Thaw all frozen meat and poultry before cooking.
- Prime cuts of meat do not benefit from slow cooking.
- Remove excess fat and skin unless browned first.
- Cook for 30 minutes at gas mark 6, then reduce to the slow cook setting.

Soups, casseroles and stews

- **Do not** cook casseroles over 2.7kg (6lb).
- Bring to the boil on the hotplate then cook on slow cook.
- Cook in the middle of the oven or above.
- Cover food with a tight fitting lid or tinfoil.

Vegetables

- Cut into small pieces.
- Dried beans must be pre-soaked then boiled in an open pan for 15 minutes before adding to any dish.
- Place vegetables under meat in casseroles.
- Cover food with a tight fitting lid or tinfoil.
- Cook for 30 minutes at gas mark 6, then reduce to the slow cook setting.

Milk puddings

- Cover the cereal with boiling water and allow to stand for 30 minutes.
- Drain and make the pudding in the usual way.
- Cook for 30 minutes at gas mark 6, then reduce to the slow cook setting.

General points for slow cooking

Frozen foods

Thaw thoroughly before cooking.

Thickening

Toss meat in flour for casseroles. Alternatively blend cornflour with water and add at the end of cooking.

Flavouring

Flavours are retained because there is little evaporation. Adjust at the end of the cooking time.

Liquid

Reduce normal liquid quantities slightly as there is little evaporation during cooking time.

Milk and milk products, for example cream

Add these towards the end of cooking to prevent them from curdling.

Reheating

Left over food should be cooled quickly and refrigerated.

Do not reheat food using the slow cook setting. Reheat food conventionally or in a microwave. Food must only be reheated once.

Care and cleaning

For your safety

For hygiene and safety reasons you must keep this gas appliance clean. A build up of fat or other foodstuff could cause a fire.

Try to mop up spills and splashes as soon as they happen. But be careful as parts of the appliance will be **hot**.

Do not use any polishes, caustic cleaners, abrasives, washing soda or soap powder except those recommended in this booklet.

Please note: If we recommend you use **hot** soapy water we mean **hot** water with washing up liquid in it and not any other cleaning product.

If you own a dishwasher please read the operating instructions for the machine before you wash any part of your appliance.

Clean your appliance regularly using a cloth that has been wrung out in hot soapy water. Rinse and polish it dry using a soft cloth.

Stainless Steel cream cleaners are abrasive and should be avoided as they may damage the surface finish.

When you remove parts of your appliance for cleaning **do not** plunge them into water whilst they are very **hot** as this may damage the finish of the parts.

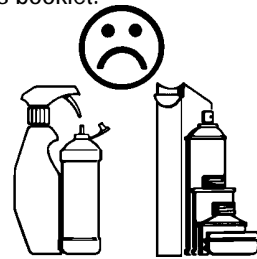

Cleaning the handles and control knobs

Do not remove the control knobs from the appliance as damage may occur. It is strongly recommended that only hot soapy water and a soft cloth is used for cleaning the door handles and control knobs. **ANY OTHER CLEANING MATERIALS MAY DULL THE FINISH.** Care should be taken when cleaning, to ensure that all cleaning products are wiped from the control knobs immediately.

The hotplate

Clean the hotplate top using a mild abrasive such as 'Cif'. Take care not to damage the spark electrodes. If the spark electrodes are damaged the burners will not light.

You can remove the pan supports, burner caps and burner crowns to clean them. Again take care not to damage the spark electrodes. If any food spills during cooking you can place the pan on another burner to finish cooking. Then you can remove the dirty parts and clean them before the spill 'burns on'.

Clean the burner crowns by soaking them in very **hot** soapy water. You can remove any stubborn stains by scouring with a soap filled pad such as 'Brillo'. If you look after the burner crowns in this way they will stay reasonably clean. However the surface will dull with time.

Aluminium based saucepans can leave shiny metal marks on the pan supports. Clean the pan supports regularly to remove the marks using a mild abrasive like 'Cif' with a soft scourer. For more stubborn marks you can use a soap-filled pad such as 'Brillo'.

After cleaning the appliance parts, dry them thoroughly before you put them back.

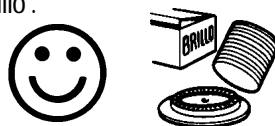

When replacing hotplate burner parts

1. Crown to body (**Do not** try to force the crown on to the body).

Make sure that the hole in the crown is over the electrode. Check that the two longer location pegs sit in the slots in the body. When the crown is in this position let it fall freely on to the body. Check that the crown can be moved slightly from side to side.

2. Cap to crown

Place cap centrally on the top of crown (enamel side up). Move sideways and front to back to check the cap is properly fitted.

3. Check for ignition

If a burner will not light then you need to check the crown and cap positions.

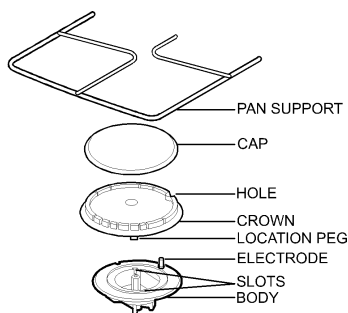

The grill

Do not clean the grill burner itself.

The burner is designed to be self cleaning. Cleaning the grill may cause the holes in the burner to become blocked preventing it from operating correctly.

Please note that due to the nature of stainless steel the grill burner may tarnish through use over a period of time. This is quite normal and is not a fault on the appliance.

Clean the area around the grill frequently using hot soapy water.

After use you can soak the pan for a few minutes and then clean it using mild abrasives or a soap filled pad such as 'Brillo'.

Clean the grill shelf using hot soapy water. Mild abrasives can be used if necessary.

The grill and top oven

Clean the grill and top oven frequently using hot soapy water.

After use you can soak the grill pan for a few minutes and then clean it using mild abrasives or a soap filled pad such as 'Brillo'.









Clean the shelf, grill pan grid and handle using hot soapy water. Mild abrasives can be used if necessary. The heat in the oven will change the colour of the solid plate on the shelf. You must not remove the solid plate from the shelf. You can soak the shelf in hot soapy water for a few minutes to make cleaning easier.

The main oven

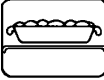
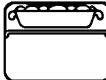
The sides and back of your oven are coated in a special material which helps to keep itself clean.

Follow these simple rules to maintain the appearance of the special finish.



- 1  **Do not** overfill dishes or they will boil over. 
- 2  **Do not** put dishes too high in the oven. If you do they may stick to the oven roof. 
- 3  Cover your roasting tins with foil. This will prevent fat splashing. 
- 4  Use a roasting tin which is just large enough for the meat and potatoes. This will help to reduce fat splashing. 
- 5  Dry any vegetables that you are going to roast. If they are wet there will be more fat splashing. 
- 6 Follow the oven cleaning cycle regularly.

Main oven cleaning cycle

Please note: The oven cleaning cycle can only be used in the main oven.

You need to follow the cycle to keep the inside of the oven in good condition. The type of cooking you do will affect how often you need to follow the cycle.

If you do a lot of roasting and very little other baking you should follow the cleaning cycle once a week. If you do very little roasting you will only need to follow the cleaning cycle every 2-3 weeks.

To carry out a cleaning cycle:

1. Remove the oven shelves.
2. Set the oven to mark 5 for at least 30 minutes.

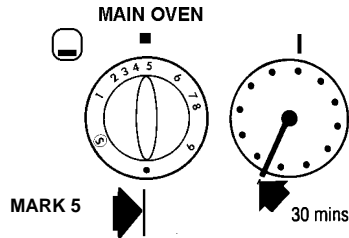

3. Turn the temperature up to mark 7 for 2 hours or until the oven is presentably clean. Some staining will remain.

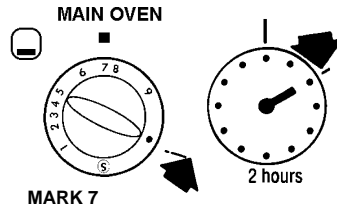

Do not use any cleaning agents or scrapers on the inside of the oven. **Do not** wash the special finish.



You can replace the oven roof if you need to. You may order this from your supplier. When you are ordering quote part number 359001018.

General

Clean the base of the oven, the oven shelves and the oven door while they are still slightly warm. This way you can easily remove any splashes or spills. Wipe the oven base with a cloth that has been wrung out in hot soapy water. You may use mild abrasives.

Cleaning between the outer and inner door glass.

You can remove the glass from the oven and grill doors if you need to.

Note: For top oven door it is important not to open the door when the glass is removed because the door is lighter and it will spring shut.

To remove the outer glass

- 1 Open the door so you can get at the two cross head screws on the top of the door.

Note: Open top oven door slightly to access screws.

- 2 Loosen these two screws using a pozidrive screwdriver.
- 3 You should hold the door glass securely in place with one hand, whilst removing the screws completely, with the other hand. If you do not do this, the door glass could fall forward.
- 4 Using both hands, gently tilt the top of the door glass towards you. Lift it slightly to disengage the locators at the bottom of the door.

Please note that the door glass on your product may differ in type and shape from that shown in the diagram.

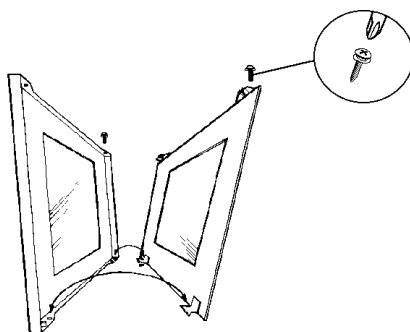

- 5 Clean the outer and inner glass using hot soapy water and mild abrasives such as 'Cif'. **DO NOT** try to clean the foil which is inside the door. The foil is there to keep the door cool, if it is damaged it will not work.
- 6 Replace the glass by holding it in both hands and gently placing the locators into the holes of the brackets at the bottom of the door, and make sure the screw location holes line up.
- 7 Hold the glass in place with one hand and replace the cross head screws into the location holes, with the other hand.
- 8 Tighten the screws using a pozidrive screwdriver. Close the door.

Cleaning The Door Glass

 To prevent damaging or weakening the door glass panels avoid the use of the following:

- Household detergents and bleaches
- Impregnated pads unsuitable for non-stick saucepans
- Brillo/Ajax pads or steel wool pads
- Chemical oven pads or aerosols
- Rust removers
- Bath/Sink stain removers

 If the door glass panel becomes chipped or has deep scratches the glass will be weakened and must be replaced to prevent the possibility of the panel shattering. Please contact your local Service Force Centre who will be pleased to advise further.

Installing the appliance

For your safety

This appliance must be installed and serviced by a competent person as stated in the Gas Safety (Installation & Use) regulations current editions and the IEE Wiring Regulations. It is important that the appliance is suitable for your gas supply. Your installer should check the rating plate. Make sure that a stability bracket is fitted.

Location

For your safety

The use of a gas cooking appliance results in the production of heat and moisture in the room in which it is installed. Ensure that the kitchen is well ventilated: keep natural ventilation holes open or install a mechanical ventilation device (mechanical extractor hood). Prolonged intensive use of the appliance may call for additional ventilation, for example opening of a window, or more effective ventilation, for example increasing the level of mechanical ventilation where present. For further details see page 42.

Positioning

The diagram shows how close to the appliance cupboards, shelves, curtains and so on can be fitted. Look at the diagram and carefully read the instructions to make sure your appliance is fitted safely. If you are in doubt your installer will give you advice.

- Do not fit any materials which may catch fire, for example wood or curtains behind the appliance.
- Base units which are higher than the hotplate must be 100mm away.

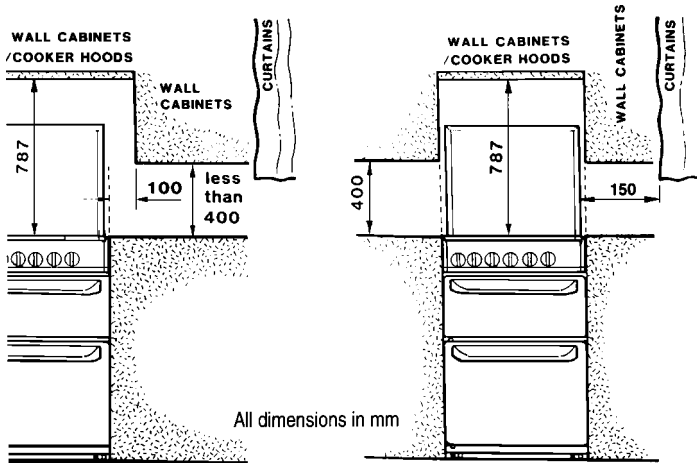

- If a cooker hood is fitted check the cooker hood installation instructions.
- We recommend that cabinets fitted next to or above the appliance meet British Standards. Your installer will give you advice if you are not sure.

Appliance dimensions

Height to hotplate:	900mm - 920mm (adjusted by four screw feet)
Width:	594mm
Depth:	600mm (to front of door panel)

General information

For your safety

Do not block any of the appliance vents.

Never line any part of the appliance with aluminium foil.

Do not let items which can catch fire or electric mains leads such as kettle flexes trail over any part of the appliance.

Moving your appliance

You may damage some soft or badly fitted floor coverings when you move the appliance. The floor covering under the appliance should be securely fixed so it does not ruck up when you move the appliance across it. Alternatively you could remove the floor covering.

To move the appliance open the second oven door. Raise the appliance off its front feet by lifting it from inside the oven. Pull the appliance forward. When you replace the appliance push it back to the stop and make sure there is the same gap at each rear corner.

For your safety

Do not try to disconnect the appliance from the gas supply if the supply pipe does not have a bayonet connection, as described in the installation instructions. If this is the case contact the person who installed the appliance.

Connecting to the electricity supply

For your safety

This appliance must be earthed and protected by a 3 amp fuse.

The plug supplied with the appliance can be fitted directly to a suitable three pin earthed socket. Ensure the plug is accessible to the user.

If you have to change the fuse replace it with a 3 amp fuse which has been ASTA approved to BS 1362.

Do not use the plug until you have put the fuse cover back on. If the fuse cover is lost you can get a replacement from an electrical retailer. The correct replacement can be identified by marking or colour coding.

If you cut the plug off dispose of it safely as it will be a shock hazard if it is inserted into a 13 amp socket elsewhere in the house.

If the ignition system doesn't work there may be a fault with the electrical supply. First, check the socket by trying out another piece of electrical equipment in it, if that works correctly renew the fuse in the plug.

If the fuse keeps failing there is a fault in the appliance which must be put right. **Do not** use a fuse with a rating higher than 3 amps. **Do not** carry out other electrical work. Unplug the appliance and tell your installer.

Replacing the oven light bulb

You need a 25 Watt small Edison screw with a temperature rating of T300.

- Make sure the oven is cool before you replace a bulb.
- Unplug the appliance.
- Open the oven door and remove the oven shelves.
- Place palm of hand at top of lens flat against oven side. Use fingers to lever lens away from housing.
- Unscrew the bulb by turning it to the left.
- Fit a new bulb and then replace the glass bulb cover.
- Replace the oven shelves.
- Plug the appliance back into the electricity supply.

The oven light bulb is not covered by the manufacturer's guarantee.

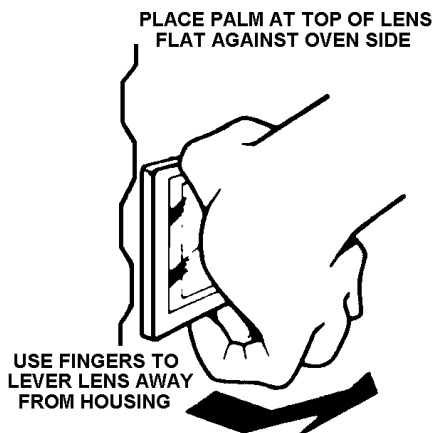

What is wrong and why?

We strongly recommend that you carry out the following checks on your appliance before calling a Service Engineer.

Problem

The oven, grill or hotplate will not light.

Check

- If only the hotplate burners will not light make sure that the burner parts have been replaced correctly. See instructions on page 27.
- If you cannot hear any sparking when you press the ignition button there may be a fault with the electrical supply. First check the socket by trying out another piece of electrical equipment in it. If that works, renew the fuse in the plug. Use a 3 amp fuse. If the fuse 'blows' again there is a fault on the appliance. **Do not** use a fuse with a rating higher than 3 amps. **Do not** carry out other electrical work. Unplug the appliance and tell your installer. If the appliance will not light because there is an electrical power failure such as a power cut you cannot use the main oven. All other burners may be lit with a match.
- Check that there is not a problem with your gas supply. You can do this by making sure that other gas appliances such as your central heating or gas fire are working.

Problem

Food is cooking too quickly or too slowly.

Check

- Check that you are using the recommended gas marks and shelf positions. See pages 16 - 21. Be prepared to adjust the gas mark up or down to get the results you want.

Problem

The oven is not cooking evenly.

Check

- Check that the appliance is installed properly and is level.
- Check that the oven roof is pushed fully back into position.
- Check that you are using the recommended size baking trays. See page 14.
- If you are cooking a large item be prepared to turn it round during cooking.
- All food in the second oven should be turned round.

Problem**Having difficulty cleaning any part of the appliance.****Check**

- Check that the instructions for care and cleaning, beginning on page 26 are being followed.

Problem**The oven light will not work.****Check**

- If the light does not work you probably need to replace the bulb. To do this see instructions on page 35.
- Check there is not a fault with the electrical supply. Check this by pressing the ignition button. If you cannot hear sparking there is probably a fault.
- First, check the socket by trying out another electrical appliance in it, if that works renew the fuse in the plug. Use a 3 amp fuse. If the fuse 'blows' again this indicates that there is a fault on the appliance. **Do not** use a fuse with a higher rating than 3 amps. **Do not** carry out further electrical work. Unplug the appliance and inform your installer.

Service and spare parts

In the event of your appliance requiring service, or if you wish to purchase spare parts please contact your local Service Force Centre by telephoning:-

08705 929929

Your telephone call will be automatically routed to the Service Force Centre covering your post code area.

For the address of your local Service Force Centre and further information about Service Force, please visit the website at www.serviceforce.co.uk

Before you call an engineer check through the information under the heading 'What is wrong and why?'

**In-guarantee customers should ensure that the checks under the heading 'What is wrong and why?' have been made as the engineer will make a charge if the fault is not a mechanical or electrical breakdown.
Please note that it is necessary to provide proof of purchase for any in-guarantee service calls.**

When you report a problem try to describe the nature of the fault. Always give your appliance's full name, model and serial number. Make a note of this information in this space:

Name:

Model Number:

Serial Number:

P.N.C. Number:

For your safety

Maintenance must only be carried out by a competent /qualified person. **Do not** try to repair or alter/modify the appliance yourself as this could be dangerous.

We recommend that your appliance has an annual gas safety check carried out by our approved service organisation.

Customer Care Department

For general enquiries concerning your Electrolux appliance or further information on products, you are invited to contact our Customer Care Department by letter or telephone as follows or visit our website at www.electrolux.co.uk

Customer Care Department
Electrolux
55-77 High Street
Slough
Berkshire
SL1 1DZ

Tel: 08705 950950 *

* calls to this number may be recorded for training purposes.

For Customer Service in Ireland please contact us at the address below:

Electrolux Group (Irl) Ltd
Long Mile Road
Dublin 12
Republic of Ireland

Tel: +353 (0)1 4090753

Email: service.eid@electrolux.ie

The Gas Consumers' Council

The Gas Consumers' Council (GCC) is an independent organisation which protects the interests of gas users.

If you need advice, you will find the telephone number in your local telephone directory under Gas.

INSTALLATION INSTRUCTIONS



Serial number
on front frame. Rating Plate on
top rear of panel.

Please note that the handle and lid may differ in type and shape from that shown in the diagram.

For your safety

Where applicable Natural Gas and L.P. Gas versions of this appliance are available.

Check that this model is suitable for the type of supply available.
In the interest of safety this appliance must be installed and/or serviced by a competent person, as stated in the Gas Safety (Installation and Use) Regulations Current Editions.

TECHNICAL DATA

DIMENSIONS

	<i>Height</i>	<i>Width</i>	<i>Depth</i>
Height to hotplate	900mm (nominal)	600mm (nominal)	600mm (to front of door panel)
Space for fixing at hotplate level	2mm minimum clearance		
Space for fixing above hotplate level	Flush-see important note 'Location of Appliance' page 43.		
Minimum space above hotplate	787mm (If a cooker hood is fitted refer to the cooker hood installation instructions).		
Weight of appliance	64.5kg.		
Minimum distance from rear wall	5mm (spacer given by pressed spacer on vent panel).		

CONNECTIONS

Gas	Rear left hand side of appliance at hotplate level. Rc½ (½" B.S.P. female).
Electric	230V-240V 50 Hz mains 3 core cable is supplied with an integral, moulded plug fitted with a 3 amp fuse.

GRILL

	<i>Natural Gas</i>	<i>L.P. Gas</i>
Heat Input	2.7kW (9215 Btu/h)	2.45kW (176 g/h)
Injector Marking	121	078

HOTPLATE

	<i>Natural Gas</i>			
	R.H.F.	R.H.R.	L.H.R.	L.H.F.
Heat Input	1.0kW (3412 Btu/h)	1.9kW (6483 Btu/h)	1.9kW (6483 Btu/h)	2.9kW (9895 Btu/h)
Injector Marking	070	096	096	119
	<i>L.P. Gas</i>			
	R.H.F.	R.H.R.	L.H.R.	L.H.F.
Heat Input	1.0kW (71.85 g/h)	1.9kW (136.5 g/h)	1.9kW (136.5 g/h)	2.9kW (208.4 g/h)
Injector Marking	050	071	071	083

MAIN OVEN

	<i>Natural Gas</i>	<i>L.P.Gas</i>
Heat Input	2.4kW (8189Btu/h)	2.4kW (172.4 g/h)
Injector Marking	108	078
Thermostat By-Pass Marking	69	78

SECOND OVEN

	<i>Natural Gas</i>	<i>L.P.Gas</i>
Heat Input	2.4kW (8189 Btu/h)	2.4kW (172.4 g/h)
Injector Marking	108	078
Dual Control By-pass	0.53kW (1808 Btu/h)	0.62kW (445 g/h)

GENERAL

Ignition	H. T. Spark
Spark Gap	3-4mm

GAS CATEGORY

COUNTRIES OF DESTINATION

CAT. I_{2H}

GB, IE

CAT. I₃₊

GB, IE

IMPORTANT - SAFETY REQUIREMENTS

This appliance must be installed in accordance with the Gas Safety (Installation and Use) Regulations Current Editions and the I.E.E. Wiring Regulations. Detailed recommendations are contained in the following British Standard Codes of Practice - BS.6172, BS.5440: Part 2 and B.S.6891. All British Standards must be 'Current Editions'.

PROVISION FOR VENTILATION

This appliance is not connected to a combustion products evacuation device. It shall be installed and connected in accordance with the current installation regulations. Particular attention shall be given to the relevant requirements regarding ventilation.

The room containing the appliance should have an air supply in accordance with BS. 5440: Part 2 Current Edition. All rooms require an openable window or equivalent and some rooms will require a permanent vent as well. For room volumes up to 5m³ an air vent of 100cm² is required: for room volumes between 5m³ and 10m³ an air vent of 50cm² is required. If the room has a door that opens directly to the outside, no air vent is required. For room volumes that exceed 11m³ no air vent is required. If there are other fuel burning appliances in the same room, BS.5440: Part 2 Current Edition should be consulted to determine the requisite air vent requirements.

Prolonged intensive use of the appliance may call for additional ventilation, for example opening a window, or more effective ventilation, for example increasing the level of mechanical ventilation where present.

LOCATION OF APPLIANCE

This appliance must not be installed in a bed-sitting room of volume less than 20m³ or in a bathroom shower room or garage. It is essential that the appliance is positioned as stated below (see Fig. 1a) i.e. shelves, wall cabinets and cooker hoods must be fitted a minimum of 787mm directly above the top of hotplate and 400mm above the hotplate when fitted in line with the outside of the appliance. If the units are intended to be fitted adjacent to the appliance but less than 400mm above the hotplate, then a minimum space of 100mm must be maintained between the sides of the unit and the appliance (see Fig.1b). Curtains must not be fitted immediately behind the appliance or within 150mm of the sides of the hotplate. If fitted next to or between two base units a minimum space of 1mm must be left between each unit and the sides of the appliance. The levelling feet fitted to the appliance will achieve a nominal height to hotplate trims of 900mm +20mm. L.P.G. cookers MUST NOT be installed below ground level, i.e in a basement, or aboard any boat, yacht or other vessel.

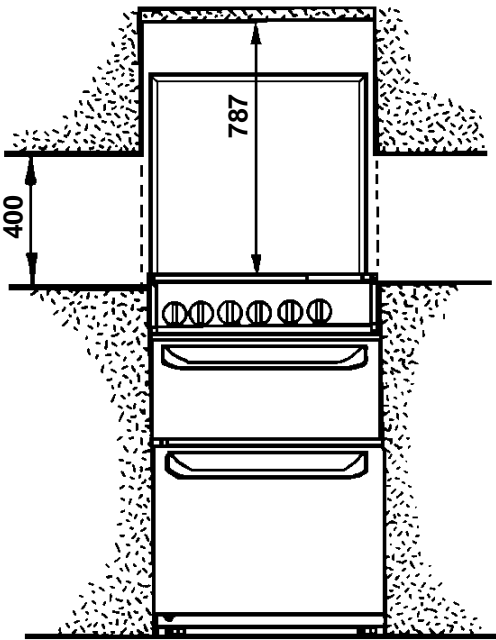

Fig.1a

All dimensions in mm

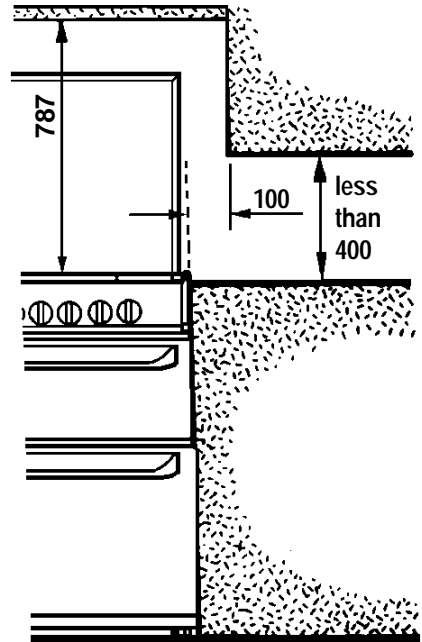

Fig.1b

INSTALLATION

1. PARTS REQUIRED

The loose hotplate parts are packed in the polystyrene fitment on top of the hotplate.

2. LEVELLING THE APPLIANCE

If the appliance requires levelling or its height adjusting (from the hotplate to any working surface), the procedure below must be followed:

1. Adjustment to suit floor conditions or height is obtained by rotating clockwise or anticlockwise the feet, at the front and rear of the appliance.
2. A spirit level should be placed on one of the oven shelves to confirm the appliance is correctly levelled.

3. FITTING THE STABILITY BRACKET

It is recommended that if the appliance is to be installed with a flexible supply pipe a stability bracket (SK.4729.A) is fitted and is available from your supplier (see Important Safety Requirements, Page 42). These instructions should be read in conjunction with the leaflet packed with the stability bracket.

1. Place the appliance in its intended position and level appliance.
2. Mark off 300mm from the left hand side of the appliance as shown in dimension 'A', Fig 2a. This is the centre line of the fixing bracket.
3. Draw a line 100mm from the front edge of the levelling feet (see Fig.2a) and remove appliance from its position. Mark off dimension 'B' (see Fig.2a) back from this line on the centre line of the bracket to locate the front edge of the lower bracket. Fix lower bracket (with two fixing holes) to the floor then measure the height from floor level to engagement edge on back of appliance, dimension 'C' of Fig.2b.
4. Assemble upper bracket to lower bracket so that underside of bracket is dimension 'C' +3mm above floor level.

Reposition appliance and check that top bracket engages into appliance back as shown in Fig. 2b.

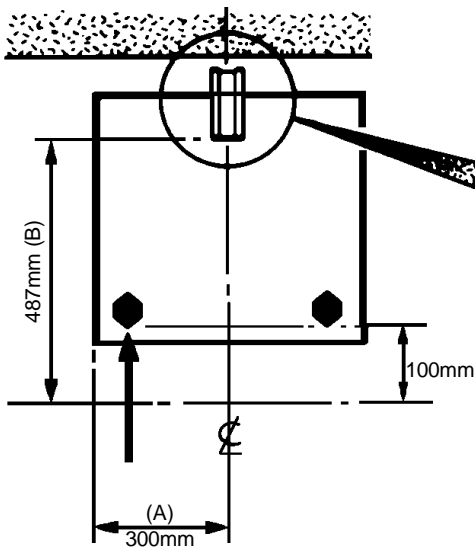

Fig.2a

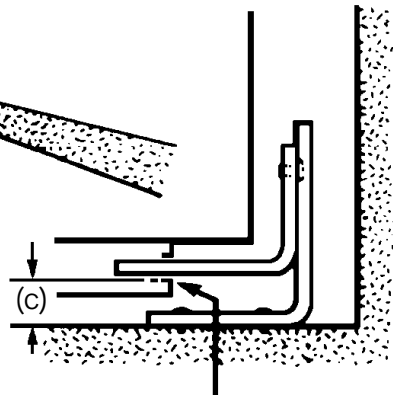

Fig.2b

4. CONNECTING TO GAS

This appliance is designed to be installed with an appliance flexible connection only. Supply piping should not be less than R³/8. Connection is made to the Rc ½ (½" B.S.P.) female threaded entry pipe located just below the hotplate level on the rear left hand side of the appliance. **NOTE: ONLY LIQUID SEALANTS TO BE USED WHEN INLET GAS PIPE IS FITTED TO SHUT OFF VALVE I.E.: DO NOT USE P.T.F.E. SEALANT TAPE.** Carry out a gas tightness test after connecting to the gas supply.

The gas bayonet connector must be fitted in the shaded area indicated in Fig.3. Take into account that it must be possible to pull the appliance forward sufficiently. The hose must not get caught on the stability bracket.

IMPORTANT: FLEXIBLE TUBING USED MUST COMPLY WITH BS. 669 CURRENT EDITION.

L.P.G. FLEXIBLE CONNECTIONS MUST BE OF A TYPE SUITABLE FOR L.P.G. AND CAPABLE OF OPERATION UP TO 50 mbar AND TO CARRY A RED STRIPE, BAND OR LABEL.

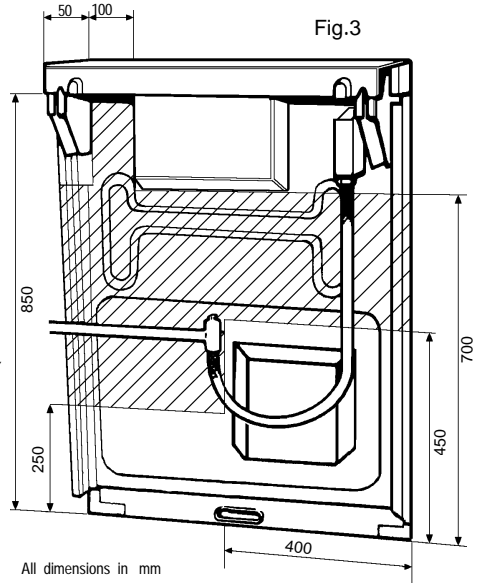

5. CONNECTION TO THE ELECTRICITY SUPPLY

WARNING: THIS APPLIANCE MUST BE EARTHED. DO NOT EARTH THIS APPLIANCE TO THE GAS SUPPLY PIPING.

This appliance must be connected to 230V-240V A.C. 50Hz supply. It is supplied with 2 metres of 5 amp 3 core cable incorporating a moulded 13 amp plug, fitted with a 3 amp fuse, which can be plugged directly into the nearest suitable socket. Ensure the plug is accessible to the user. If this is not long enough, the supply cable can be replaced totally by a longer cable at least 0.75mm² nominal cross sectional area (24/0.2mm).

IF THE MOULDED PLUG IS CUT FROM THE CABLE FOR ANY REASON, IT MUST BE DESTROYED OR DISPOSED OF SAFELY, AS THE PROTRUDING WIRES WILL BE AN ELECTRIC SHOCK HAZARD.

If any other type of plug is used it should incorporate a 3 amp fuse in either the plug or adapter or at the distribution board.

If the cable has to be threaded through small apertures in cabinets etc., it may be disconnected from the appliance, then re-connected to as shown in Fig.4.

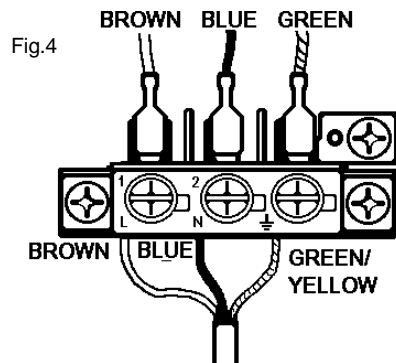

DO NOT EXTEND THE CABLE USING PLASTIC OR CERAMIC CONNECTION TERMINAL BLOCKS AND/OR INSULATION TAPE.

ALL EXTERNAL WIRING BETWEEN THE APPLIANCE AND THE ELECTRICAL SUPPLY SHALL COMPLY WITH I.E.E. WIRING REGULATIONS.

If the wiring is extended or a completely new cable fitted a 3-pin 13 amp plug should be fitted. (See Fig.4a). Connect the wires as follows:

BROWN to the Live Terminal.

BLUE to the Neutral Terminal.

GREEN and YELLOW to the Earth Terminal.

As the colours of the wires in the mains lead which you fit may not correspond with the coloured markings identifying the terminals in your plug, proceed as follows:

The wire which is GREEN and YELLOW must be connected to the terminal in the plug which is marked with the letter 'E' or by the earth symbol \perp or coloured GREEN or GREEN and YELLOW.

The wire which is coloured BLUE must be connected to the terminal which is marked with the letter 'N' or coloured BLACK.

The wire which is coloured BROWN must be connected to the terminal which is marked with the letter 'L' or coloured RED.

FIT A 3 AMP FUSE TO THE PLUG HOLDER.

Ensure that the supply cable cannot get caught by the stability bracket. **Plug in the appliance.**

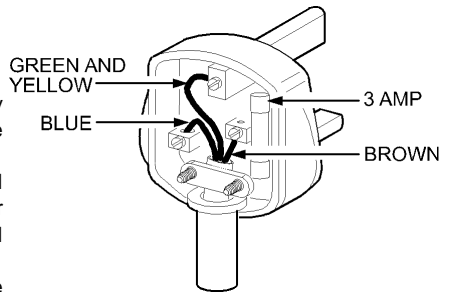

Fig.4a

6. PRESSURE TESTING

1. The oven injector is used as a pressure test point.
Remove the oven furniture. Remove oven burner box retaining clips (one spring clip from each side) and remove box front cover. Replace one clip back into the right hand side of the burner box.
Remove oven burner by removing the spring clip from the right hand side of the oven burner and slide burner off injector whilst easing it forward and taking care not to strain the F.S.D. phial.
2. Connect the pressure gauge to the oven injector.
3. Check the supply pressure by turning the thermostat on and one hotplate tap full on and light the appropriate burner. The pressure should be either:-
 - (i) For Natural Gas 20mbar
 - (ii) For LP.Gas The pressure must be set to 28 mbar for use on butane or 37 mbar for use on propane.Turn off the taps, disconnect the pressure gauge and replace oven burner and cover, ensuring that the F.S.D. phial is correctly located into the bracket on the burner.
5. Check operation of oven.

7. CHECKING THE GRILL

Place the grill pan containing the grid, with the handle attached, into the grill compartment. Light the grill burner by turning the grill tap to its full on position and pushing the ignition button. As soon as the burner is lit the button can be released.

8. CHECKING THE HOTPLATE

Lift the lid. Fit the burner crowns and caps ensuring that they are correctly seated. Fit the pan supports. Check each of the hotplate burners in turn by turning the hotplate tap to its full on position and pushing the ignition button. As soon as the burners are lit the button can be released.

9. CHECKING LID SHUT-OFF DEVICE

1. Lift the lid.
2. Turn one hotplate burner tap to its full on position and push the ignition button.
3. Close lid. There should now be no gas supply to the hotplate and the burner will go out.
4. Turn off the hotplate tap and lift the lid. The gas supply should now be restored to the hotplate. When the tap is turned on.

10. CHECKING THE MAIN OVEN

1. Turn the oven thermostat to Mk.9 and check that there is sparking from the ignition system. This should continue until the oven burner is alight.
2. When the oven burner lights up the sparking should cease, there should be a low gas rate at first to the oven burner which is the flame supervision device (F.S.D.) by pass rate.
3. When the F.S.D. phial has heated up it opens the F.S.D. valve and the main gas stream flows to the burner.
4. After 1 minute check that the flame covers the full width of the burner and is stable.
5. Set the oven thermostat to Mk.2, close the oven door and check that after about 10 minutes the flame has reduced in size.
6. Turn off the thermostat and check that the oven flames go out.

11. CHECKING THE SECOND OVEN

1. Turn the second oven thermostat control knob anticlockwise to Mk8 and press the ignition button. As soon as the burner is alight the button can be released.
2. When the oven burner lights up there should be a low gas rate at first to the oven burner which is the F.S.D. by-pass rate.
3. When the F.S.D. phial has heated up it opens the F.S.D. valve and the main gas stream flows to the burner.
4. After 1 minute check that the flame covers the full width of the burner and is stable.
5. Set the oven control to Mk. 2, close the oven door and check that after approx. 10 minutes the flame size has reduced.
6. Turn off the control knob and check that the oven flames go out.

12. CHECKING THE MAIN OVEN LIGHT

Turn the main oven thermostat knob full on and check that the main oven light is operative. Turn off the thermostat.

13. TO SET THE TIME OF DAY

To set the clock (See Fig 5).

1. Turn on electricity supply and ensure that the thermostat is in the off position.
2. Press buttons (1) and (2) together.
3. Release buttons, 0.00 will appear in the display.

Within 5 seconds press button (2), 12.00 will show in the display.

4. **Within 5 seconds** press and hold either button (1) to decrease or button (2) to increase the time until the correct time of day on the 24 hour clock is reached, e.g.14.30.

FIG.5

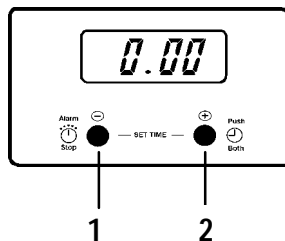

14. MINUTE MINDER OPERATION

The minute minder gives an audible reminder at the end of any period of cooking up to 23 hours and 59 minutes.

To set press button (1) and the display will read 0.00.

Release button (1) and press and hold button (2). The display will count up in one minute intervals until the interval to be timed is reached, eg 30 minutes. If necessary press and hold button (1) to achieve the correct time interval.

The bell symbol  will show in the display.

The minute minder will begin to count down once set. The time of day will show in the display. To show the remainder of the cook time press button (1).

At the end of the time period an audible signal will sound for up to 2 minutes.

The bell symbol will flash and the time of day will show in the display.

To stop the sound press button (1). The bell symbol will go out and show the time of day eg 15.00.

GENERAL NOTE

Instruct the user on how to use the appliance and its ignition system. Refer the user to the wording in the inside cover which gives advice on the safe operation of the appliance.

Guarantee Conditions

Standard guarantee conditions

We, Electrolux, undertake that if within 12 months of the date of the purchase this Electrolux appliance or any part thereof is proved to be defective by reason only of faulty workmanship or materials, we will, at our option repair or replace the same FREE OF CHARGE for labour, materials or carriage on condition that:

- The appliance has been correctly installed and used only on the electricity supply stated on the rating plate
- The appliance has been used for normal domestic purposes only, and in accordance with the manufacturer's instructions
- The appliance has not been serviced, maintained repaired, taken apart or tampered with by any person not authorised by us
- All service work under this guarantee must be undertaken by your local Service Force Centre.
- Any appliance or defective part replaced shall become the Company's property
- This guarantee is in addition to your statutory and other legal rights

Home visits are made between **8.30am** and **5.30pm** Monday to Friday. Visits may be available outside these hours in which case a **premium** will be charged.

Exclusions

This guarantee does not cover:

- Damage or calls resulting from transportation, improper use or neglect, the replacement of any light bulbs or removable parts of glass or plastic
- Costs incurred for calls to put right an appliance which is improperly installed or calls to appliances outside the United Kingdom
- Appliances found to be in use within a commercial environment, plus those which are subject to rental agreements
- Products of Electrolux manufacture which are not marketed by Electrolux

European Guarantee

If you should move to another country within Europe then your guarantee moves with you to your new home subject to the following qualifications:

- The guarantee starts from the date you first purchased your product
- The guarantee is for the same period and to the same extent for labour and parts as exists in the new country of use for this brand or range of products
- This guarantee relates to you and cannot be transferred to another user
- Your new home is within the European Community (EC) or European Free Trade Area
- The product is installed and used in accordance with our instructions and is only used domestically, i.e. a normal household
- The product is installed taking into account regulations in your new country

Before you move please contact your nearest Customer Care centre, listed below, to give them details of your new home. They will then ensure that the local Service Force Centre is aware of your move and able to look after you and your appliances.

France	Senlis	+33 (0) 3 44 62 20 13
Germany	Nürnberg	+49 (0) 800 234 7378
Italy	Pordenone	+39 (0) 800117511
Sweden	Stockholm	+46 (0) 20 78 77 50
UK	Slough	+44 (0) 1753 219 898
Ireland	Dublin	+353 (0) 1 4090753

NOTES

DDO61GA - 311686800

Contents Check List

Note:

If you require replacements of the item listed below please contact your local Service Force Centre quoting the relevant part number.

The loose contents of this pack include:-

No. OFF	DESCRIPTION
2	Main Oven shelves
1	Guarantee card
1	Grill pan grid(small wire) (311419801)
1	Grill pan (311409401)
1	Detachable grill pan handle (311468100)
1	Grill/second oven shelf
4	Burner crowns
4	Burner caps
1	Pan support (left-hand large) (311594302)
1	Pan support (right-hand large) (311594303)

Note :

If you require an additional handle for your grill pan. This can be ordered from your local Service Force Centre by quoting part number 311479800/6.

IMPORTANT NOTICE

In line with our continuing policy of research and development, we reserve the right to alter models and specifications without prior notice.

This instruction booklet is accurate at the date of printing, but will be superseded if specification or appearance are changed.

ELECTROLUX
55 - 77 HIGH STREET,
SLOUGH,
BERKSHIRE,
SL1 1DZ.
TELEPHONE 0870 5 950950

Part Number:311686800



© Electrolux plc 2003

 **The Electrolux Group.** *The world's No.1 choice.*

The Electrolux Group is the world's largest producer of powered appliances for kitchen, cleaning and outdoor use. More than 55 million Electrolux Group products (such as refrigerators, cookers, washing machines, vacuum cleaners, chain saws and lawn mowers) are sold each year to a value of approx. USD 14 billion in more than 150 countries around the world.